

FRONT ELEVATION

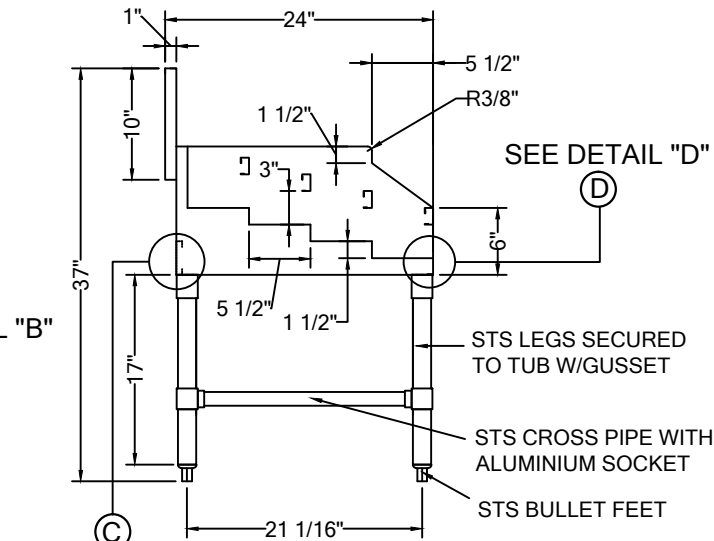

PLAN VIEW

- 18 GA. 304 STAINLESS STEEL CONSTRUCTION.
- STS LEGS WITH ADJUSTABLE STS BULLET FEET.

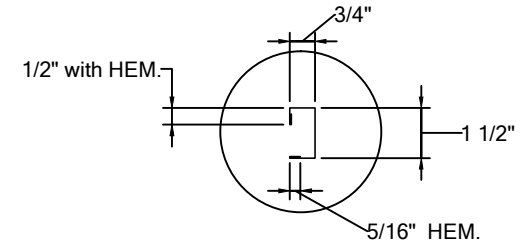

DETAIL "A"

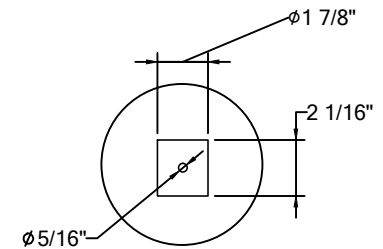

DETAIL "B"

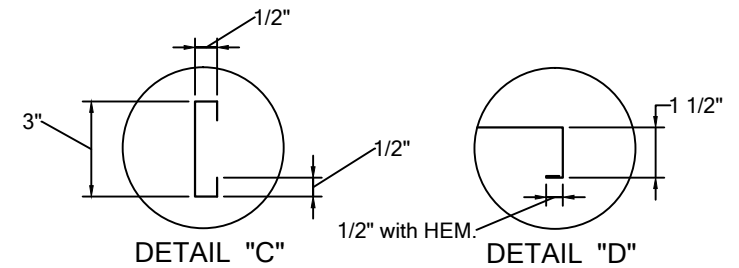

DETAIL "C"

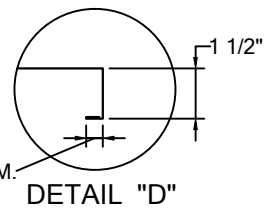

DETAIL "D"

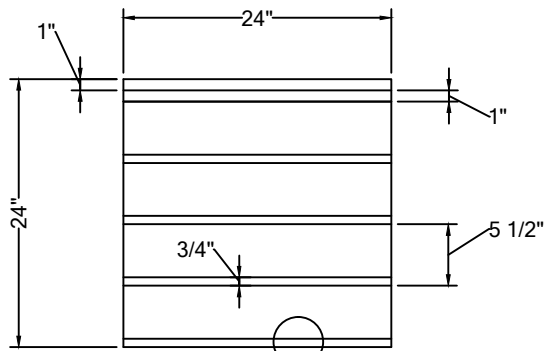

PLAN VIEW

SEE DETAIL "A"

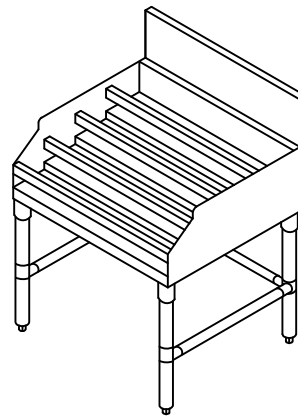

ISOMETRIC

DRAWIN FOR :	MAT.	TOP : 18GA. 304S/S	DATE	REVISIONS
REF. NO :	REQ'D/ITEM :	BASE :		
ITEM NAME : Bar Stairs	DATE : Jul / 12 / 2017			
PROD. NO. : TA-BBR2424	BY :			
SCALE: 1/2" =1'-0"	CHECKED BY :			

Tarrison
Products Ltd.