



CB15T

Heavy-Duty, One Gallon Food Blender with Electronic Keypad & Timer



*Made in USA with US and foreign parts.

ELECTRICAL

Voltage: 120
Frequency: 50/60Hz
Watts: 1800
Amps: 15
Plug Type: A
Cord Length: 6.6 feet



MAIN FEATURES

- Ultra-heavy-duty, 3.75 HP commercial motor – perfect for large loads and long blending times
- 3-speed selection and MAX PULSE to chop and mix
- Easy-to-clean and easy-to-use electronic-membrane keypad
- 3-minute countdown timer with automatic shutoff – start the blender and go attend to something else; it will blend perfectly, then shut off when it's done
- 1 gallon stainless steel container with two handles for carrying and pouring, and lid clamps for security
- Easy-off, rubberized lid with removable clear cap for adding ingredients and for pressure reduction during hot food blending
- Durable, high-performance stainless steel blade
- Metal-on-metal, stainless steel coupling system for durability and reliability
- Durable, full die-cast motor housing with rugged rubber feet to reduce vibration
- Dishwasher-safe, one-piece jar pad for easy cleaning
- Recommended for 100+ drinks or servings per day
- Limited Three-Year Motor Warranty

SALES FEATURES

Blend up to one gallon of smoothies, soups, sauces and more with the Waring® CB15T. This ultra-heavy-duty blender chops, mixes and shreds large loads with a powerful 3.75 HP motor. The 3-minute countdown timer lets you start blending and then move on to another task. It automatically shuts off when done.

Heavy-Duty, One Gallon Food Blender with Electronic Keypad & Timer

CB15T





@waringcommercial

©2019 Waring Commercial
314 Ella T. Grasso Avenue, Torrington, CT 06790
Tel. 800-492-7464 • Fax 860-496-9008

waringcommercialproducts.com

INCLUDED ACCESSORIES

-  **CAC77** Vinyl Lid for 1 Gallon Blender Jar
-  **CBL10** Hot Blending Lid for 1 Gallon Blenders
-  **CAC72** Two-Handle, 1 Gallon Stainless Steel Container with Blade Assembly and Lid

OPTIONAL ACCESSORIES

-  **CB15BU** Base Unit
-  **CAC125** Two-Handle, 1 Gallon Stainless Steel Container with Spigot, Blade Assembly and Lid
-  **CAC170** 1 Gallon, Stackable, 128 oz., BPA-Free Copolyester Container with Blade Assembly and Lid
-  **CAC32** 40 oz. Glass Container Complete with Blade Assembly and Lid (requires AD1)
-  **AD1** 1 Quart Adapter for 1 Gallon Blenders
-  **CAC19** 48 oz., BPA-Free Copolyester Container Complete with Blade Assembly and Lid (requires AD1)
-  **CAC33** 32 oz. Stainless Steel Container Complete with Blade Assembly and Lid (requires AD1)
-  **CAC02** Outer Lid ONLY for 48 oz., BPA-Free Copolyester or 64 oz. Stainless Steel Container
-  **CAC04** Outer Lid ONLY for 32 oz. Stainless Steel Container
-  **CAC05** Center Lid ONLY for CAC01, CAC02, and CAC04

DIMENSIONS

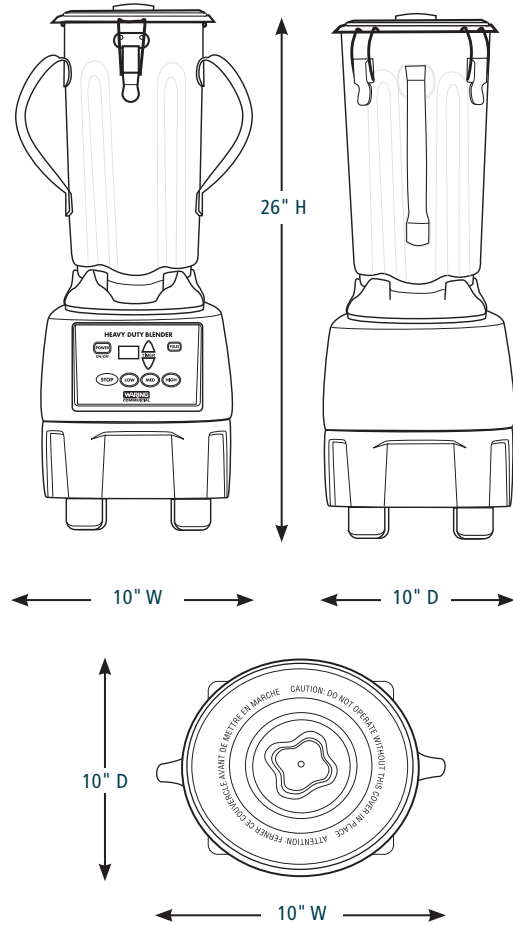

Out of Box Weight: 32.4 lb.

ORDERING INFORMATION	#STD. PKG.	GIFTBOX WEIGHT	CUBIC FEET	BOX DIMENSIONS L x W x H	UPC	CASE PKG.	MC WEIGHT	MC DIMENSIONS L x W x H	MBC
CB15T – One Gallon, 3-Speed Food Blender with Electronic Keypad & Timer	1	38	2.9	22.125" x 15" x 15.25"	040072000829	1	38.6	22.125" x 15" x 15.25"	10040072000826

