

efi sales Ltd.

Equipment for the Foodservice Industry
value + quality + service

Meat Slicer - 10" Blade

SA-MSEC25

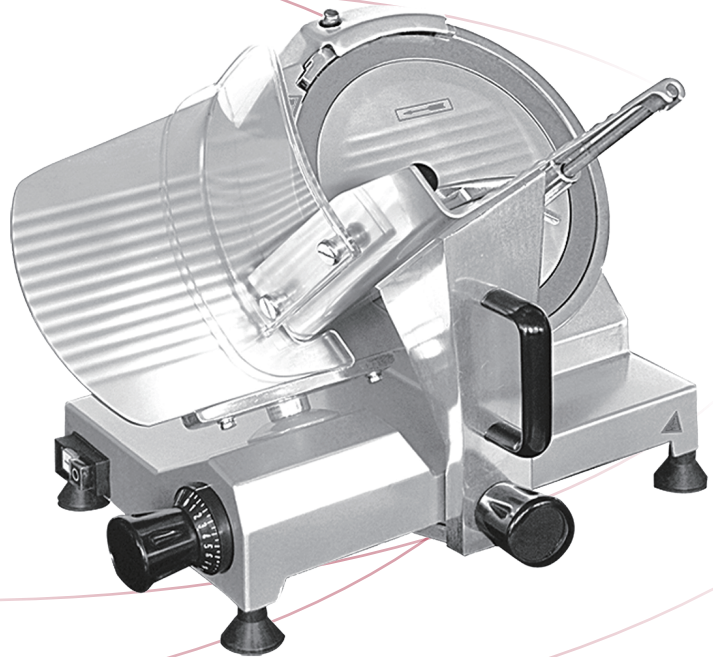

SA-MSEC25

Features

Features:

- Rugged body made from Cast Aluminum
- Ideal for slicing vegetables and processed meats
- 10 inch blade
- Slicing thickness 0.2 -12mm
- 40 slices per minutes
- 180mm maximum slice length



SA-MSEC25

Specifications

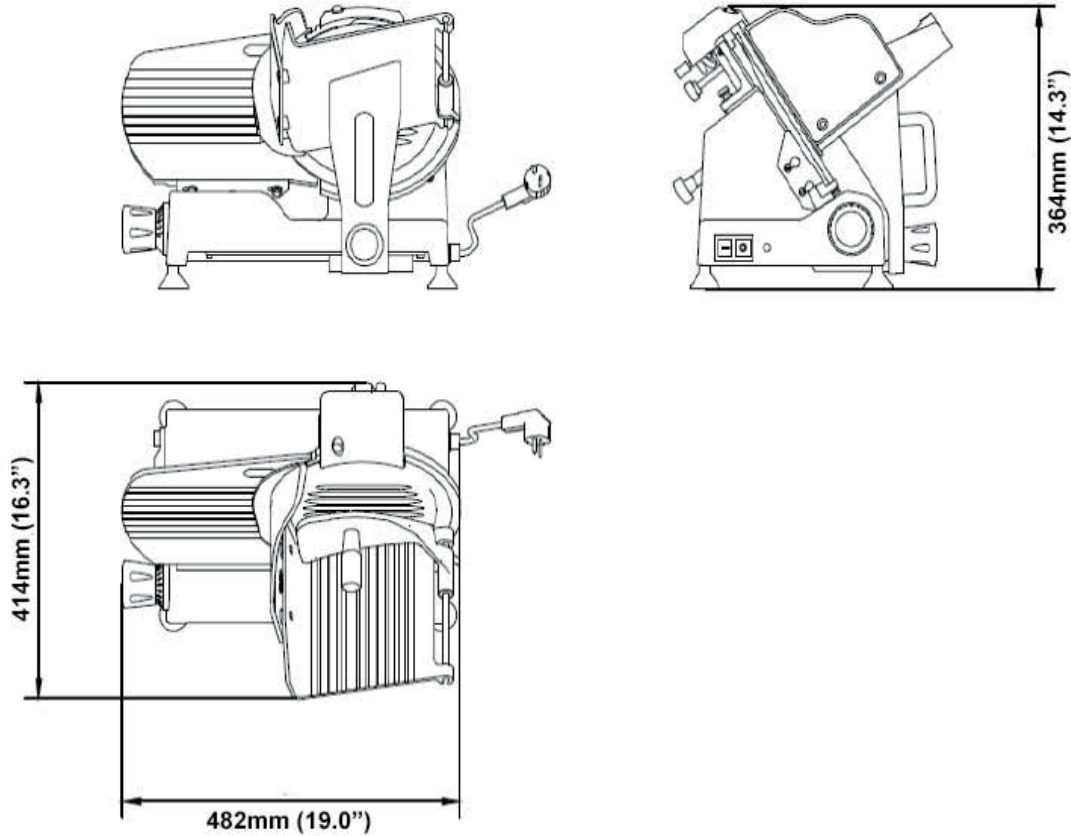

Model	Dimension (mm) (inch)			Diameter of blade (mm) (inch)	Voltage	Power	Net Weight (KG) (LBS)
	W	D	H				
SA-MSEC25	414	482	364	250	110/60	150 watts	15.5
	16.3	19.0	14.3	10			34.2

Equipped with one NEMA 5-15P plug 

Shipping Information

Crate Dimensions (mm) (inch)			Net Weight (KG) (LBS)	Gross Weight (KG) (LBS)
W	D	H		
465	575	415	15.5	17.7
18.3	22.6	16.3	34.2	39.0

Specifications subject to change without notice.