

efi sales Ltd.

Equipment for the Foodservice Industry

value + quality + service

Cube Ice Machine

IM-220



IM-220

Features

Features:

- Corrosion resistant exterior
- Door allows easy access to ice in the bin
- Durable core micro-computer control system for quick and easy operation
- A special built-in follow water type evaporator, increases the transparency and hardness of the ice
- Special injection tank, simple and clean, nice heat preservation performance, effectively keeps ice more hard
- Unique ice type gives a refreshing, crisp and clean tasting full cube sized ice

- Easy to adjust the thickness of the ice depending on your requirements

Warranty:

- One year parts and labour
- Specifications subject to change without notice



IM-220

Specifications

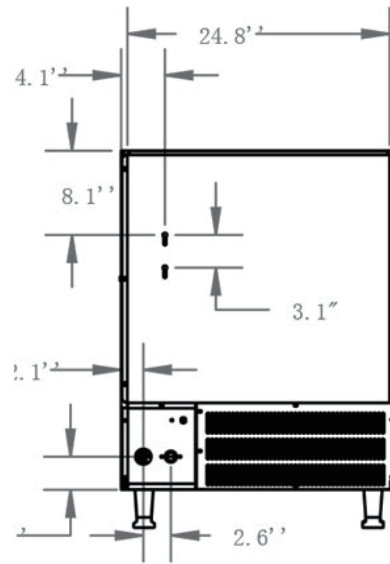
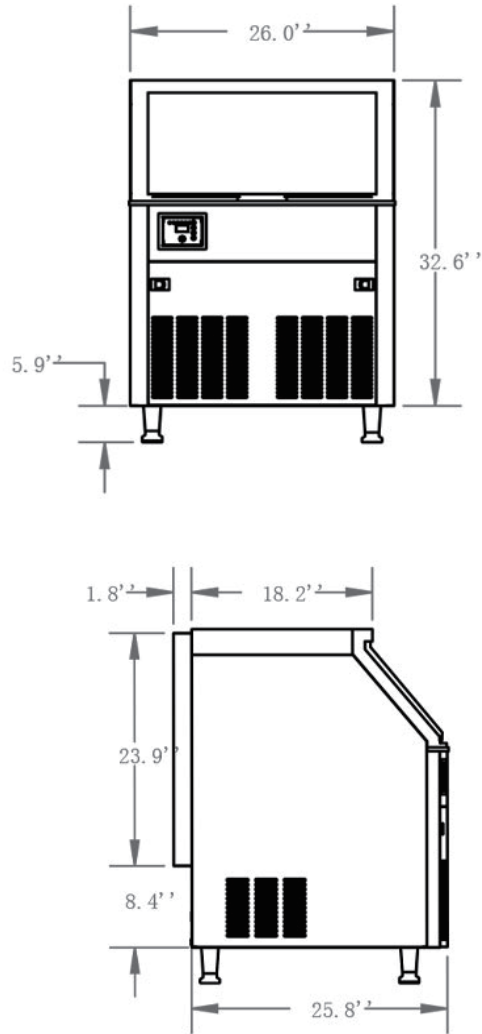

Model	Refrigerant	Dimension (mm) (inch)			Condenser Unit	Voltage (V/Hz)	Power (W)	Bin Capacity (KG) (LBS)	Output LB/24hr (KG) (LBS)	Net Weight (KG) (LBS)
		L	D	H						
IM-220	R290	660	701	978	Air	115/60	526	36	95	66
		26	27.6	38.5				80	210	145