



Equipment for the Foodservice Industry

value + quality + service

Pizza Prep Table

CPDR2-67VC



CPDR2-67VC

Features

Features:

- Exterior & interior stainless steel construction
- Environmentally friendly R290 refrigerant
- Heavy duty Embraco compressor
- Self-closing and stay open door
- Efficient refrigeration system
- Recessed door handle
- Magnetic door gaskets
- Casters for easy movement
- Pre-installed shelves
- Removable lid/top

Warranty:

- Two year parts and labour; Five years on compressor. *For full warranty details visit <https://www.efifoodequip.com/warranty-info.php>*



CPDR2-67VC

Specifications

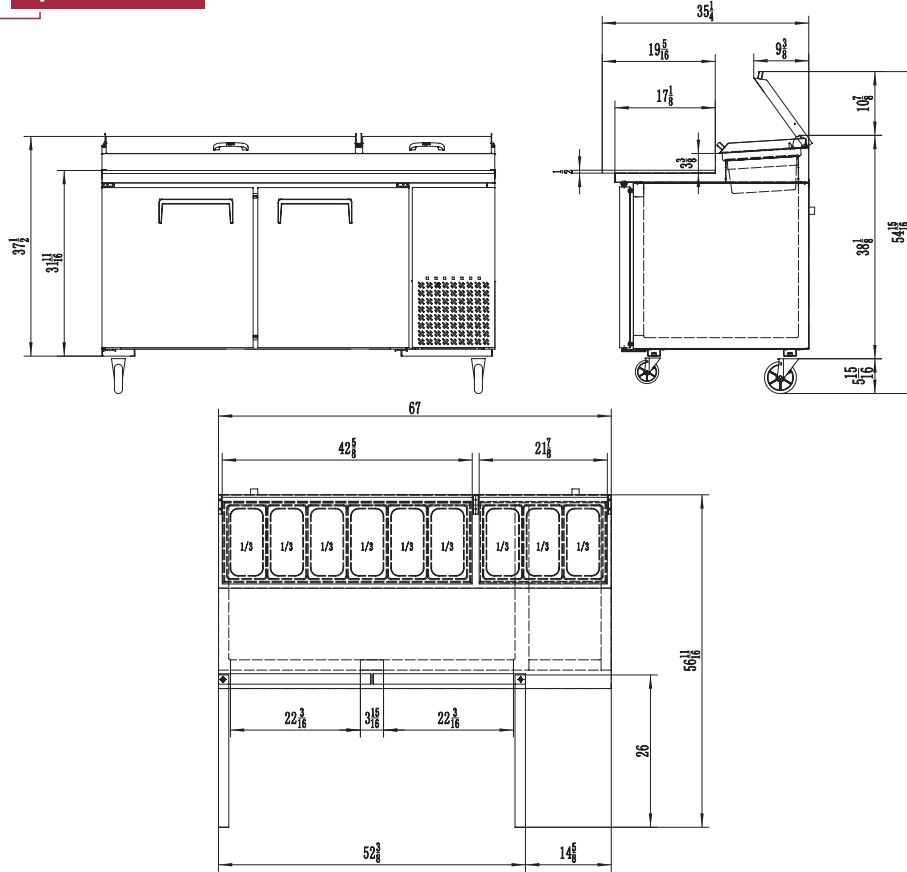

Model	Refrigerant	Doors	Shelves	Dimension (mm) (inch)			HP	Voltage	Amps	Capacity (L) (Cu Ft.)	Net Weight (KG) (LBS)	Temperature Range
				L	D	H						
CPDR2-67VC	R290	2	4	1701	840	1035	1/5	115/60	2.8	524	152	1 ~ 8°C
				67.0	33.1	40.7				18.5	334	33 ~ 45°F

Equipped with one NEMA 5-15P plug 

Shipping Information

Crate Dimensions (mm) (inch)			Net Weight (KG) (LBS)	Gross Weight (KG) (LBS)
L	D	H		
1755	909	1166	152	184
69.1	35.8	45.9	335	406

Specifications subject to change without notice.