



BEVERAGE-AIR®

PROJECT: _____
 ITEM # _____ QTY: _____
 MODEL # _____
 AIA # _____ SIS # _____
 APPROVED: _____

DELI/BAKERY CASE

Model: CDR5HC-1-W-D

DRY CASE

3 Year Parts/Labor Warranty

CABINET CONSTRUCTION



- Exterior has white powder coated galvanized steel
- Stainless steel interior with mirrored end caps
- Sliding glass, removable doors
- Curved front glass
- LED lighting with on and off switch
- Electrical outlet for scale
- Adjustable shelves for better product display
- Price tag molding standard
- Open food rated



OPTIONS & ACCESSORIES

- Refrigerated cases
- 3" Casters
- 6" Casters
- 2 3/4" Casters

BEVERAGE-AIR®

Deli/Bakery Case Model: CDR5HC-1-W-D

PLAN VIEW

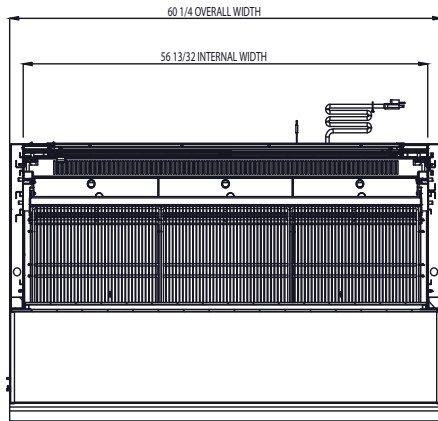

ELEVATION VIEW

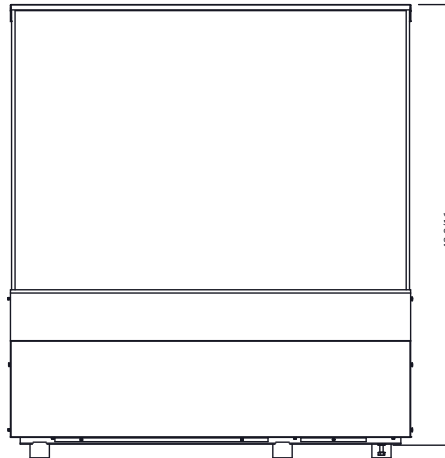

SIDE VIEW

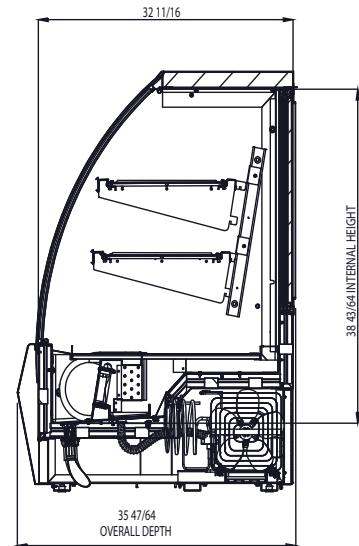

EXTERNAL DIMENSIONAL DATA	
Width Overall (in)	60 1/4"
Depth Overall (in)	35 47/64"
Height Overall (in)	48 9/16"
INTERNAL DIMENSIONAL DATA	
NET Capacity (cubic ft.)	17
Internal Width Overall (in)	56 13/32"
Internal Depth Top & Middle Overall (in)	15 11/100"
Internal Depth Overall Bottom (in)	24 37/100"
Internal Height Overall (in)	38 43/64"
Number of Shelves	2

ELECTRICAL DATA	
Nema Plug (8' cord)	5-15P
SHIPPING DATA	
Gross Weight - Crated	571 lbs.
Height - Crated (in)	58"
Width - Crated (in)	68"
Depth - Crated (in)	39"

ELECTRICAL CONNECTION



NEMA 5-15P Unit pre-wired at factory and include 8' long cord and plug set.

We reserve the right to change specifications and product design without notice. Such revisions do not entitle the buyer to corresponding changes, improvements, additions or replacements for previously purchased equipment. Dimensional tolerances +/- 1/4". Metric dimensions (MM).

Required Clearance: Do not block grille (3" rear)

3779 Champion Blvd., Winston-Salem, NC 27105 | 888-845-9800 | Fax: 336-245-6453 | Beverage-Air.com | Sales@bevair.com

Date Issued 9/25 | Printed in U.S.A.