

Height: 29.4" Width: 11.7" Depth: 23.7"
 (74.7cm) (29.7cm) (60.2cm)



- Sleek, modernized design language on the brewer, with rounded angles on the corners and trunk
- Digital readout displays in English, Spanish, or French ---for easier programming and control--- and can show either 'Standard' or Metric measurements. Digital readout also shows machine status, and targeted advertising messages can be programmed for display.
- BUNN Infusion Series technology allows for multiple recipes from one footprint --- with three brew buttons and two batch sizes
- Easy pulse display allows for simplified programming of pulse routine
- Compact, low-profile styling to accommodate a variety of spaces
- Energy-saver mode reduces tank temperature during idle periods
- Exclusive Peak Extraction™ Sprayhead is multi-directional with a 7-hole design to ensure ultimate uniformity of extraction
- Electronic funnel lock prevents removal of each brew funnel until drip- through is complete
- USB programming capable
- Brew counter keeps track of how many batches are brewed
- Pre-infusion and pulse brew for maximum flavor extraction. Cold brew lockout & digital temperature control further ensure top-notch brewing.
- Includes overlay kit for customization of brewer interface

Agency:

 Server(s) sold separately



Specifications

Product #: 52000.6101

Legs: 4" Black Legs

Water Access: Plumbed

Finish: Stainless

Funnel: Translucent Tea Funnel

Additional Features

Electrical & Capacity

Volts*	Amps	Watts	Cord Attached	Plug Type	8oz cups/hr 236ml cups/hr	Input H ₂ O Temp.	Phase	# Wires plus Ground	Hertz
120	14	1700	-	-	336	60°F (15.5°C)	1	2	60

*When a BUNN is machine rated 120/208-240V, 120/208V or 120/240V, the higher voltage is the supply voltage needed to power the machine. The 120V is there to supply power to some components rated 120V in the machine, but it is not the supply voltage and would not power the machine if the machine is marked with the before mentioned ratings.

Plumbing Requirements

PSI	kPa	Fitting Supplied	Water Flow Required (GPM)
20-90	138-621	1/4" Male Flare Fitting	1.25

CAD Drawings

2D	Revit	KLC
●		

 **WARNING:**



BUNN® reserves the right to change specifications and product design without notice. Such revisions do not entitle the buyer to corresponding changes, improvements, additions or replacements for previously purchased equipment. For most current specifications and other info visit bunn.com.

Last Updated:
01/26/2022

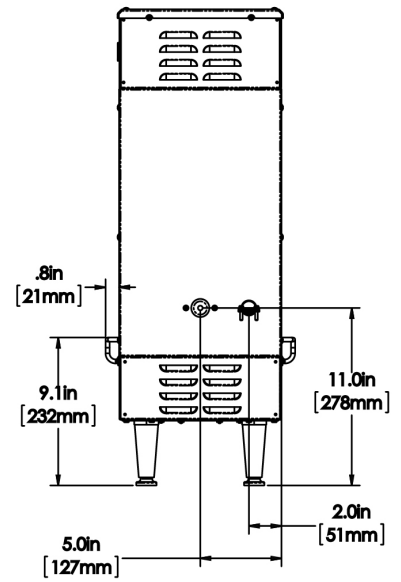
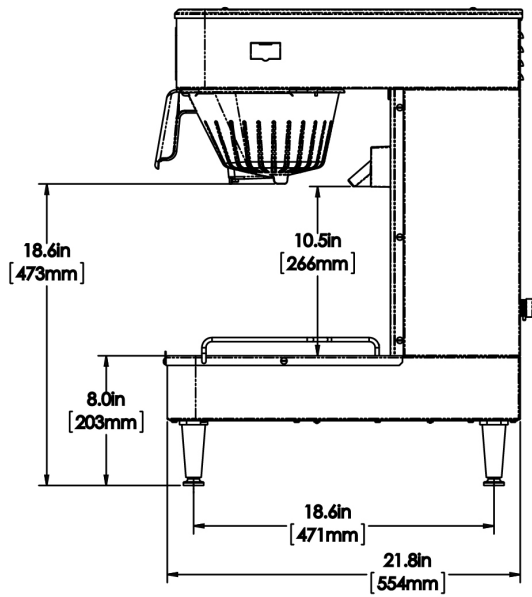
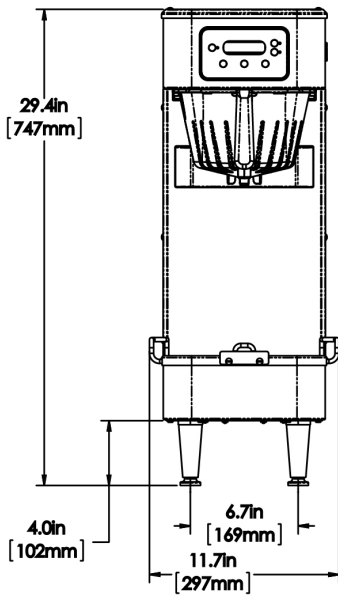
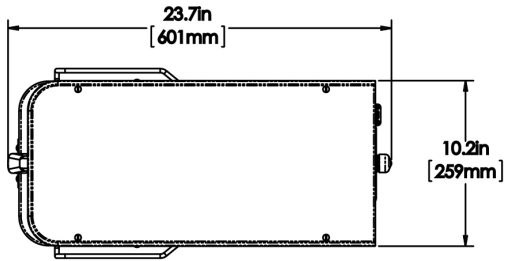

	Unit			Shipping				
	Height	Width	Depth	Height	Width	Depth	Weight	Volume
English	29.4 in.	11.7 in.	23.7 in.	-	-	-	-	-
Metric	74.7 cm	29.7 cm	60.2 cm	-	-	-	-	-



BUNN® reserves the right to change specifications and product design without notice. Such revisions do not entitle the buyer to corresponding changes, improvements, additions or replacements for previously purchased equipment. For most current specifications and other info visit bunn.com.

Last Updated:
01/26/2022

Related Products & Accessories:(52000.6101)



FILTERS, GOURMET 500
500/1 50/CL

Product #: 20138.1000

FUNNEL ASSY,BLK
SMART COFFEE-
CLEARED CAN

Product #: 53463.7007

FUNNEL ASSY, TEA
NATURAL CDN@

Product #: 53463.7040



BUNN® reserves the right to change specifications and product design without notice. Such revisions do not entitle the buyer to corresponding changes, improvements, additions or replacements for previously purchased equipment. For most current specifications and other info visit bunn.com.

Last Updated:
01/26/2022

Serving & Holding Options: (52000.6101)



TDO-3.5,LP RSVR BREW
THRU

Product #:37100.0000



BUNN® reserves the right to change specifications and product design without notice. Such revisions do not entitle the buyer to corresponding changes, improvements, additions or replacements for previously purchased equipment. For most current specifications and other info visit bunn.com.

Last Updated:
01/26/2022