

TDO-N-3.5 Low Profile Disp w/Solid Lid

Height: 0.0" Width: 0.0" Depth: 0.0"
(0.0cm) (0.0cm) (0.0cm)



- Available Serving Rack and Booster takes advantage of open counter-to-ceiling layouts while also freeing space for a variety of beverages stations or configurations
- Low profile design fits into height-restricted layouts and is more manageable to transport
- Reinforced edges stand up to the demands of busy serving environments
- Front – back handles maximizes counter space usage, built in back lower handle for easy emptying and cleaning
- Lid included
- Ships with full-color iced tea decal
- Sump dispense valve assures complete dispensing
- Two dispensers, placed side-by-side, allow added flexibility in menu options within the same footprint as one cylinder or oval dispenser

Agency:



Specifications

Product #: 39600.0065

Finish: Stainless

Handle: Front/Back Carry Handles

Lid Color: Black

Additional Features

Standard Dispense Faucet

Holding Capacity

English	Metric
-	-

 **WARNING:**



BUNN® reserves the right to change specifications and product design without notice. Such revisions do not entitle the buyer to corresponding changes, improvements, additions or replacements for previously purchased equipment. For most current specifications and other info visit bunn.com.

Last Updated:
03/30/2023

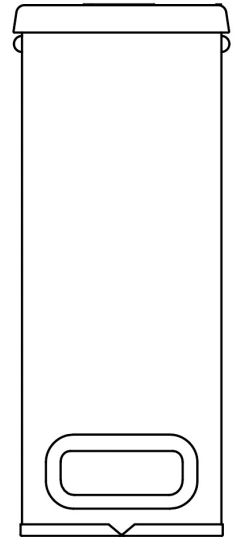
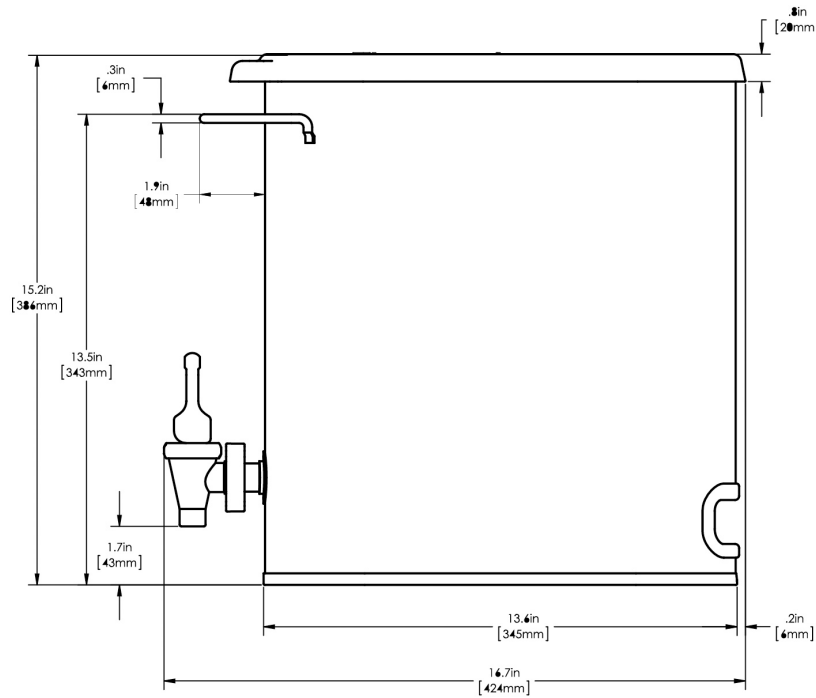
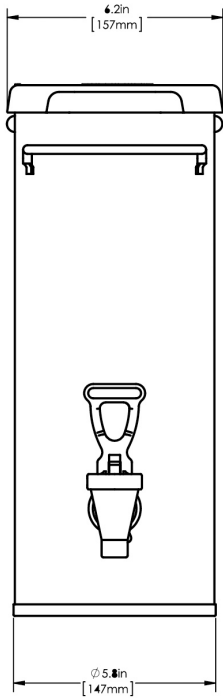
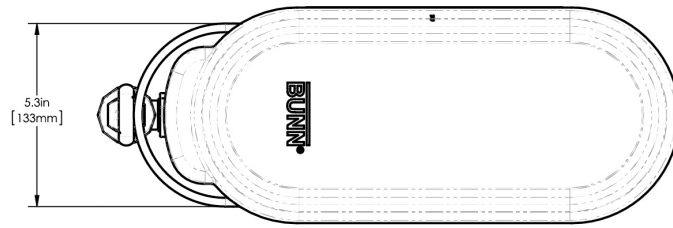

	Unit			Shipping				
	Height	Width	Depth	Height	Width	Depth	Weight	Volume
English	-	-	-	15.7 in.	6.4 in.	16.2 in.	5.470 lbs	0.937 ft ³
Metric	-	-	-	39.8 cm	16.2 cm	41.2 cm	2.481 kgs	0.027 m ³



BUNN® reserves the right to change specifications and product design without notice. Such revisions do not entitle the buyer to corresponding changes, improvements, additions or replacements for previously purchased equipment. For most current specifications and other info visit bunn.com.

Last Updated:
03/30/2023

Related Products & Accessories:TDO-N-3.5 Low Profile Disp w/Solid Lid(39600.0065)



DISPENSE RACK,
SINGLE LP TDO-N

Product #: 49634.0000



SLIDE LID ASSY TDO-N

Product #: 50534.1000



BOOSTER, WIRE FORM
TDO-N2.0/3.5

Product #: 50845.0000



BUNN® reserves the right to change specifications and product design without notice. Such revisions do not entitle the buyer to corresponding changes, improvements, additions or replacements for previously purchased equipment. For most current specifications and other info visit bunn.com.

Last Updated:
03/30/2023

Model Compatibility: TDO-N-3.5 Low Profile Disp w/Solid Lid(39600.0065)

Serving and Holding selections are currently unavailable. Please contact your sales representative to find out more information.



BUNN® reserves the right to change specifications and product design without notice. Such revisions do not entitle the buyer to corresponding changes, improvements, additions or replacements for previously purchased equipment. For most current specifications and other info visit bunn.com.

Last Updated:
03/30/2023